

KMEW

Quality Distributed By



Wall

2024 | 02 |

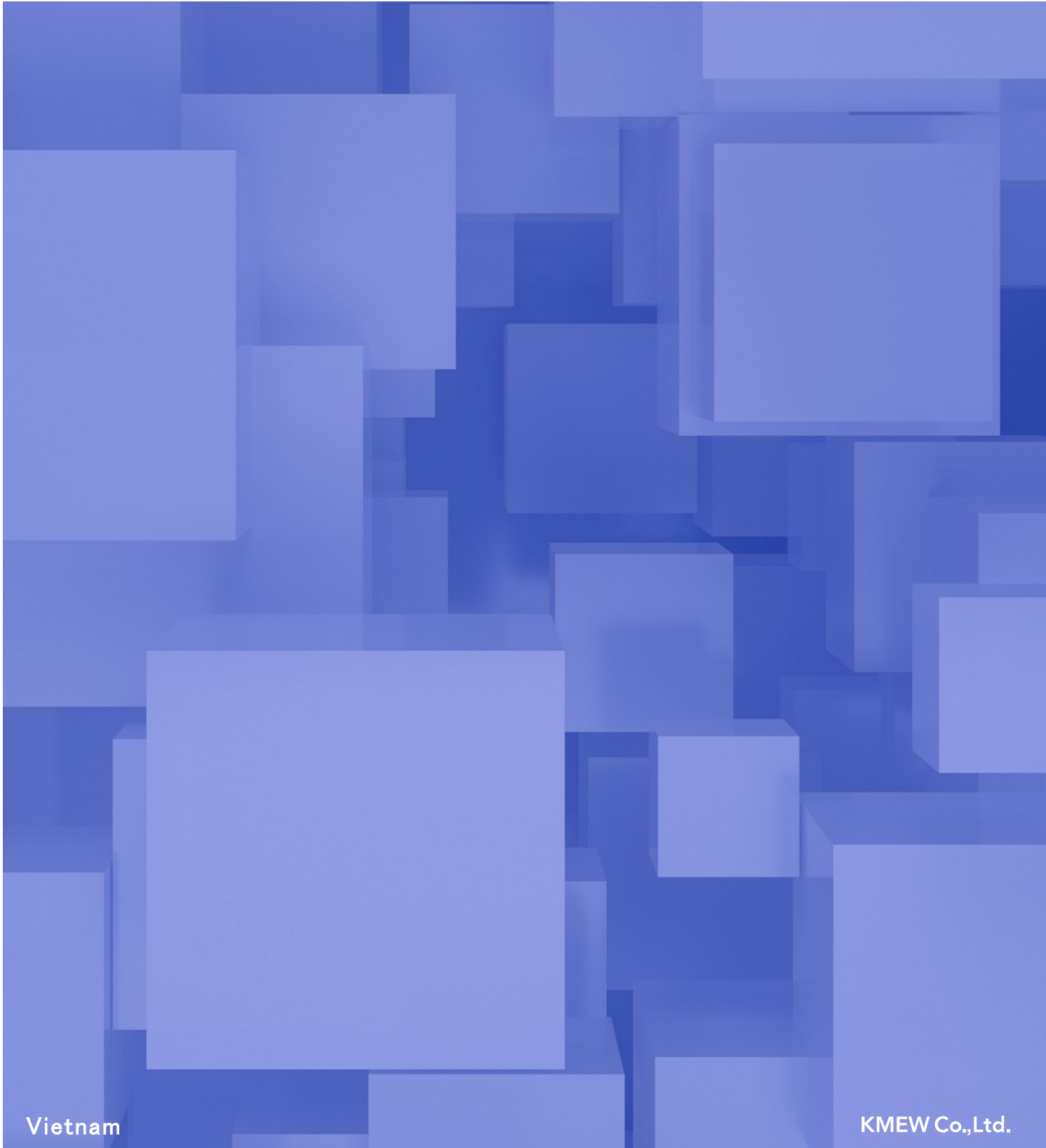



Products

Legerair / FLAT DESIGN PANEL / Neorock Photocatalytic Ceramic Coating /
Filltect Photocatalytic Ceramic Coating / Excellage Photocatalytic Ceramic Coating

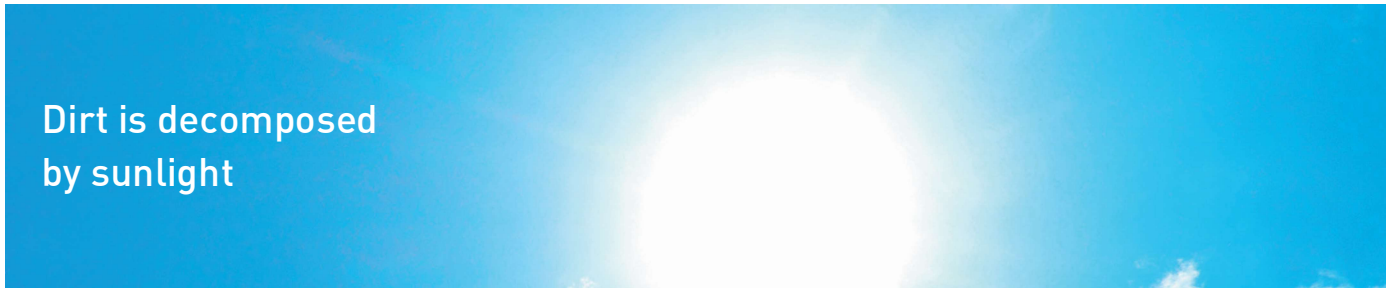

Decomposition Power

Dirt is decomposed by the sun (Ultraviolet Rays), weakening adhesion.

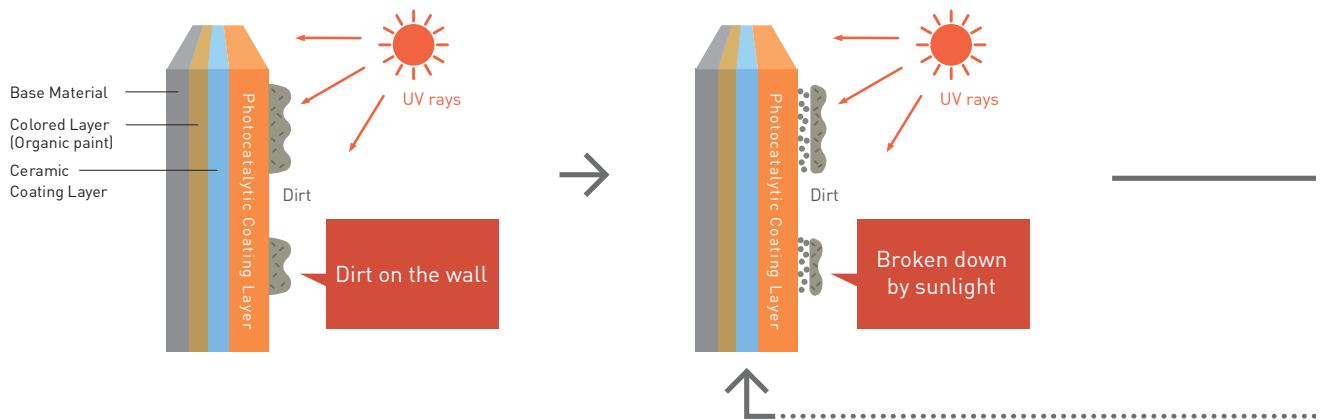

Air-purifying Function

Photocatalytic coat decomposes pollutants in the air and exhaust gas (NOx and SOx) into clean air .

The air purification capability of Photocatalytic coat of 165m² is worth 12 poplars.

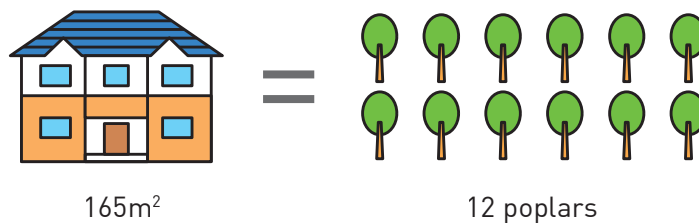

*Assuming a poplar tree's air purifying capability (NO2) is 0.57g / day

Compatibility with water allows for easy cleaning.

Super Hydrophilic Property

Due to the extreme compatibility with water, rainwater rinses off dirt.

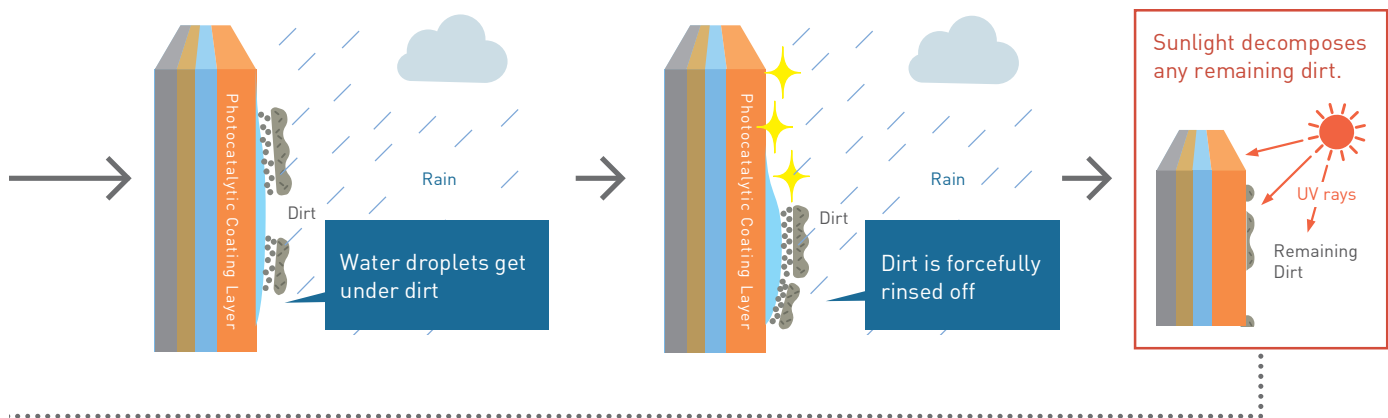

The ceramic coating layer offers strong protection against fading and sunburning

Super Weather Resistance

The double effects of the inorganic resin and the inorganic UV absorber protects against over time and cuts UV rays.

Point 1: Inorganic resin

The main framework is 100% inorganic with bonds that are strengthened by UV energy to prevent deterioration over time.

■ Molecular structure diagram

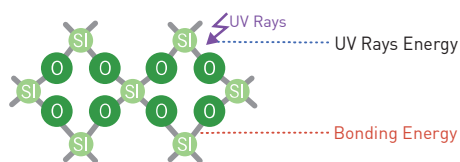

Bonds are not easily broken

Molecular Bonds

413 KJ / mol
Kilo Jules per mole

443KJ / mol

Increased strength from UV energy to prevent bonds from being easily broken

Point 2: Inorganic UV absorber

The inorganic construction helps prevent deterioration and is able to cut UV rays.



Products

Neorock Hydrophilic coating / Excellage Hydrophilic coating
Filltect Hydrophilic coating / Ceradir Hydrophilic coating



Compatibility with water allows for easy cleaning.

Washed away by rainwater. Water gets on the dirt and washes the dirt away

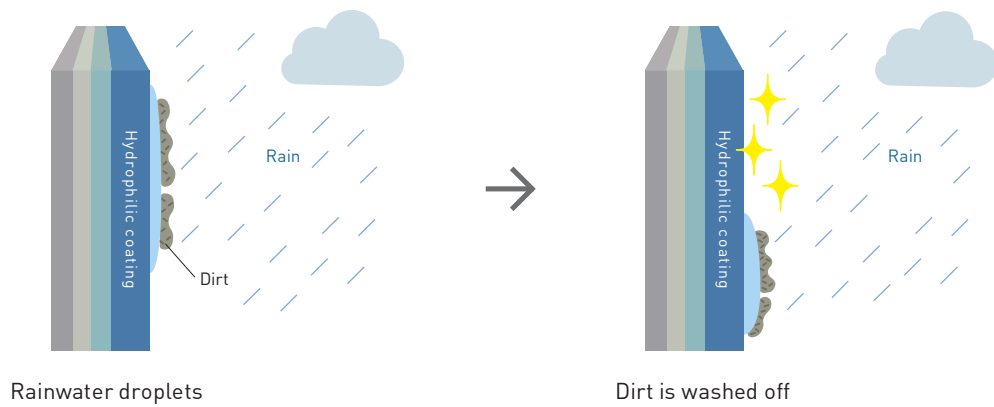

Advanced hydrophilic coating technology helps wash away dirt accumulated on the panel with rainwater. After panel being cleaned with rainwater from dirt, moisture remains on the hydrophilic surface. The color coating is strongly protected from moisture.

Hydrophilic

The panel structure is formed from the substrate, base paint protective clear coating and hydrophilic coating.

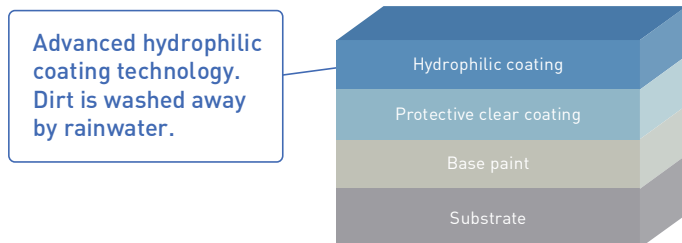





Filltect Hydrophilic 16
Tiers Tije FT
FW7142A

Filltect Hydrophilic 16

Ridge Wave FT
 Accurate FT
 New Slim Stone FT
 Natural Brick FT
 Ofen Brick FT
 Tiers Tile FT
 Drawer Tile FT
 Sephiro Wood FT
 Smash Line FT
 Stripe 10 FT
 Strahl FT
 Fiotto FT
 Scre Flat FT

■ Performance List

item	unit	Filltect Hydrophilic 16	note
		16mm thickness	
specific gravity	—	1.0*	Drying at 105°C for 24 hours
Water content	%	20 or under	JISA5422
Water absorption rate	%	50 or under	Water absorption 24h→105°C 24h
Bending Failure Load	N	785 or over	JISA5422
Impact resistance	—	Passed	JISA5422

*These are our measured values.

Filltect Hydrophilic 16

16 mm thickness | Filltect Hydrophilic 16

16x455x3030(mm) | 8,300JPY/piece 6,020JPY/m²

Hydrophilic Self-cleaning
Weather resistance grade ★

Ridge Wave FT

Installation
Horizontal



FW4911U



FW4913U



FW4914U

Accurate FT

Installation
Horizontal



FW7131U



FW7132U



FW7133U



FW7134U

New Slim Stone FT

Installation
Horizontal and Vertical



FW4861U



FW4863U



FW4864U



FW4865U

Natural Brick FT

Installation
Horizontal



FW4921U



FW4922U



FW4923U



FW4924U

Ofen Brick FT

Installation
Horizontal



FW7155A



FW7156A



FW7157A



FW7158A

Tiers Tile FT

Installation
Horizontal



FW7141A



FW7142A



FW7143A



FW7144A



FW7145A



FW7146A

Drawer Tile FT

Installation
Horizontal



FW4931U



FW4932U



FW4933U



FW4934U

Sephiro wood FT

Installation
Horizontal and Vertical



FW4871U



FW4872U



FW4873U



FW4874U

Filltect Hydrophilic 16

16 mm thickness | Filltect Hydrophilic 16

16x455x3030(mm) | 7,900JPY/piece 5,730JPY/m²

Hydrophilic
Self-
cleaning

Weather
resistance grade
★

Smash Line FT

Installation
Horizontal



FW4881U



FW4882U



FW4883U



FW4884U

Stripe 10 FT

Installation
Horizontal and
Vertical



FW7161U



FW7162U



FW7163U



FW7164U



FW7165U



FW7167U

Strahl FT

Installation
Horizontal



FW7171U



FW7172U



FW7173U



FW7175U

Fiotto FT

Installation
Horizontal and
Vertical



FW4891U



FW4892U



FW4894U



FW4895U

Scre Flat FT

Installation
Horizontal and
Vertical

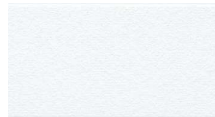

FW7281A

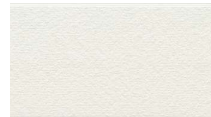

FW7282A



FW7283A

Ridge Wave FT

Coating performance	Weather resistance	Installation
Hydrophilic Self-cleaning	Weather resistance grade ★	Installation Horizontal



FW4911U



FW4913U



FW4914U

Specifications

Size	16×455(exposed width)×3030mm
Price	8,300 JPY /piece 6,020 JPY/m ²
Number of panel per package	2 pieces
Coverage	1.38m ² /piece
Weight	Approx. 26kg/piece

Outside corner



Accessories list

Genuine accessories are required to install siding panels

Panel	Accessories			
	Outside corner l=455	Caulking (Holder set: B80E)	Repair Paint	
FW4911U	FWD4911U	B84303859	B93HB3003BU	B93HB3080AU
FW4913U	FWD4913U	B8430409	B93HB2413BU	B93HB3098BU
FW4914U	FWD4914U	B84303878	B93HB2417AU	B93HB3220BU
Price	3,800 JPY /piece	6,000 JPY /piece	2,600 JPY /bottle	
Number of panel per package	10 pieces/box (Ordering Unit 1piece)	10 pieces/box ^{*1} (Ordering Unit 1piece)	60g/bottle	
		Caulking(600ml)10pieces, Primer,brush,nozzle2pieces <small>*1 Holder set are sold separately</small>		

*1 The dedicated primer (part number B85AA or B85BB) will be shipped at the same time.

Accurate FT

Coating performance	Weather resistance	Installation
Hydrophilic Self-cleaning	Weather resistance grade ★	Installation Horizontal



FW7131U

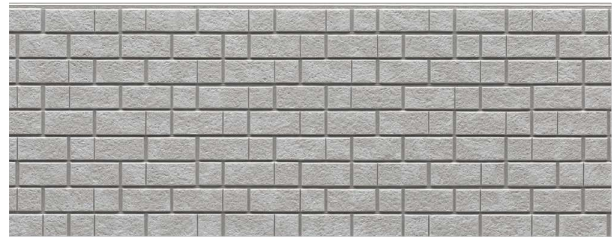

FW7132U



FW7133U



FW7134U

Specifications

Size	16×455(exposed width)×3030mm
Price	8,300 JPY /piece 6,020 JPY/m ²
Number of panel per package	2 pieces
Coverage	1.38m ² /piece
Weight	Approx. 26kg/piece

Outside corner



Accessories list

Genuine accessories are required to install siding panels

Panel	Accessories	Outside corner l=455	Caulking (Holder set: B80E)	Repair Paint
FW7131U		FWD7131U	B84302491B	B93HB2670AU —
FW7132U		FWD7132U	B84303211	B93HB1436AU (Light color) B93HB3213AU (Dark color)
FW7133U		FWD7133U	B84303045	B93HB2583AU (Light color) B93HB3210AU (Dark color)
FW7134U		FWD7134U	B84303045	B93HB2416BU —
Price		3,800 JPY /piece	6,000 JPY /piece	2,600 JPY /bottle
Number of panel per package		10 pieces/box (Ordering Unit 1piece)	10 pieces/box*1 (Ordering Unit 1piece) Caulking(600ml)10pieces, Primer,brush,nozzle2pieces *Holder set are sold separately	60g/bottle

*1 The dedicated primer (part number B85AA or B85BB) will be shipped at the same time.

New Slim Stone FT

Coating performance	Weather resistance	Installation
Hydrophilic Self-cleaning	Weather resistance grade ★	Installation Horizontal and Vertical



FW4861K



FW4863K



FW4864K



FW4865K

Specifications

Size	16×455(exposed width)×3030mm
Price	8,300 JPY /piece 6,020 JPY/m ²
Number of panel per package	2 pieces
Coverage	1.38m ² /piece
Weight	Approx. 24kg/piece

Outside corner

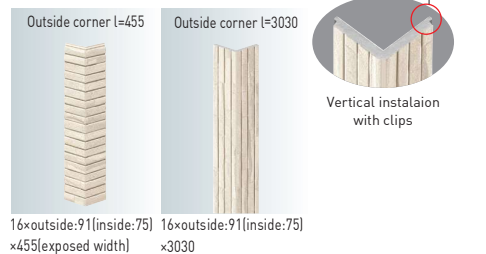

Accessories list

Genuine accessories are required to install siding panels

Panel	Accessories		Through Wall Flashing l=3030	Caulking (Holder set: B80E)	Repair Paint	
	Outside corner l=455	Outside corner l=3030				
FW4861K	FWD4861K	FWP4861K	B2241W2	B84301944	B93HB2531BU	—
FW4863K	FWD4863K	FWP4863K	B2241W4	B84301937	B93HB1623AU (Dark color)	B93HB2666AU (Light color)
FW4864K	FWD4864K	FWP4864K	B2241550	B84301935A	B93HB2533AU (Light color)	B93HB2535AU (Dark color)
FW4865K	FWD4865K	FWP4865K	B22413114	B84303869	B93HB2716BU (Dark color)	B93HB3220AU (Light color)
Price	3,800 JPY /piece	17,500 JPY /piece	2,900 JPY /piece	6,000 JPY /piece	2,600 JPY /bottle	
Number of panel per package	10 pieces/box (Ordering Unit 1piece)	1 piece	5 pieces/box	10 pieces/box*1 (Ordering Unit 1piece) Caulking(600ml)10pieces, Primer,brush,nozzle2pieces *Holder set are sold separately	60g/bottle	

*1 The dedicated primer (part number B85AA or B85BB) will be shipped at the same time.

Natural Brick FT

Coating performance	Weather resistance	Installation
Hydrophilic Self-cleaning	Weather resistance grade ★	Installation Horizontal



FW4921U



FW4922U



FW4923U



FW4924U

Specifications

Size	16×455(exposed width)×3030mm
Price	8,300 JPY /piece 6,020 JPY/m ²
Number of panel per package	2 pieces
Coverage	1.38m ² /piece
Weight	Approx. 25kg/piece

Outside corner



Accessories list

Genuine accessories are required to install siding panels

Panel	Accessories			
	Outside corner l=455	Caulking (Holder set: B80E)	Repair Paint	
FW4921U	FWD4921U	B8430746	B93HB1438CU	—
FW4922U	FWD4922U	B8430427	B93HB2413CU	B93HB3098CU
FW4923U	FWD4923U	B8430408	B93HB2529AU	B93HB2614AU
FW4924U	FWD4924U	B84302636	—	B93HB3098DU
Price	3,800 JPY /piece	6,000 JPY /piece	2,600 JPY /bottle	
Number of panel per package	10 pieces/box (Ordering Unit 1piece)	10 pieces/box ^{*1} (Ordering Unit 1piece)	60g/bottle	
		Caulking(600ml)10pieces, Primer,brush,nozzle2pieces <small>*Holder set are sold separately</small>		

*1 The dedicated primer (part number B85AA or B85BB) will be shipped at the same time.

Ofen Brick FT

Coating performance	Weather resistance	Installation
Hydrophilic Self-cleaning	Weather resistance grade ★	Installation Horizontal



FW7155A



FW7156A



FW7157A



FW7158A

Specifications

Size	16×455(exposed width)×3030mm
Price	8,300 JPY /piece 6,020 JPY/m ²
Number of panel per package	2 pieces
Coverage	1.38m ² /piece
Weight	Approx. 24kg/piece

Outside corner



Accessories list

Genuine accessories are required to install siding panels

Panel	Accessories			
	Outside corner l=455	Caulking (Holder set: B80E)	Repair Paint	
FW7155A	FWD7155A	B84304053	B93HB3106AA (Light color)	B93HB3318AA (Dark color)
FW7156A	FWD7156A	B84301653	B93HB2627CA	—
FW7157A	FWD7157A	B8430409	B93HB3217BA	—
FW7158A	FWD7158A	B8430522B	B93HB3222CA	—
Price	3,800 JPY /piece	6,000 JPY /piece	2,600 JPY /bottle	
Number of panel per package	10 pieces/box (Ordering Unit 1piece)	10 pieces/box ^{*1} (Ordering Unit 1piece)	60g/bottle	
		Caulking(600ml)10pieces, Primer,brush,nozzle2pieces		
		[*] Holder set are sold separately		

^{*1} The dedicated primer (part number B85AA or B85BB) will be shipped at the same time.

Tiers Tile FT

Coating performance	Weather resistance	Installation
Hydrophilic Self-cleaning	Weather resistance grade ★	Installation Horizontal



FW7141A



FW7142A



FW7143A



FW7144A

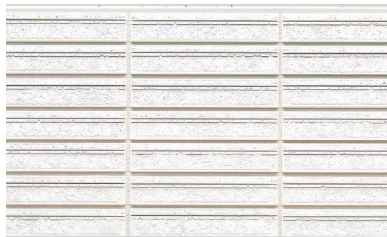

FW7145A



FW7146A

Specifications

Size	16×455(exposed width)×3030mm
Price	8,300 JPY /piece 6,020 JPY/m ²
Number of panel per package	2pieces
Coverage	1.38m ² /piece
Weight	Approx. 25kg/piece

Outside corner



Accessories list

Genuine accessories are required to install siding panels

Panel	Accessories			
	Outside corner l=455	Caulking (Holder set: B80E)	Repair Paint	
FW7141A	FWD7141A	B84301653	B93HB2456AA	—
FW7142A	FWD7142A	B84301653	B93HB2634BA	—
FW7143A	FWD7143A	B84302417B	B93HB3246AA	—
FW7144A	FWD7144A	B84303045	B93HB2417DA	—
FW7145A	FWD7145A	B84304053	B93HB3106AA (Light color)	B93HB3318AA (Dark color)
FW7146A	FWD7146A	B8430522B	B93HB3222CA	—
Price	3,800 JPY /piece	6,000 JPY /piece	2,600 JPY /bottle	
Number of panel per package	10 pieces/box (Ordering Unit 1piece)	10 pieces/box*1 (Ordering Unit 1piece) Caulking(600ml)10pieces, Primer,brush,nozzle2pieces *Holder set are sold separately	60g/bottle	

*1 The dedicated primer (part number B85AA or B85BB) will be shipped at the same time.

Drawer Tile FT

Coating performance	Weather resistance	Installation
Hydrophilic Self-cleaning	Weather resistance grade ★	Installation Horizontal



FW4931U



FW4932U



FW4933U



FW4934U

Specifications

Size	16×455(exposed width)×3030mm
Price	8,300 JPY /piece 6,020 JPY/m ²
Number of panel per package	2 pieces
Coverage	1.38m ² /piece
Weight	Approx. 25kg/piece

Outside corner



Accessories list

Genuine accessories are required to install siding panels

Panel	Accessories			
	Outside corner l=455	Caulking (Holder set: B80E)	Repair Paint	
FW4931U	FWD4931U	B84303883	B93HB2531BU	B93HB2613AU
FW4932U	FWD4932U	B8430708	B93HB3246AU	B93HB2619BU
FW4933U	FWD4933U	B84302415A	B93HB3247AU	B93HB2811AU
FW4934U	FWD4934U	B84303841	B93HB2632AU	B93HB2417AU
Price	3,800 JPY /piece	6,000 JPY /piece	2,600 JPY /bottle	
Number of panel per package	10 pieces/box (Ordering Unit 1piece)	10 pieces/box ^{*1} (Ordering Unit 1piece)	60g/bottle	
		Caulking(600ml)10pieces, Primer,brush,nozzle2pieces <small>*Holder set are sold separately</small>		

*1 The dedicated primer (part number B85AA or B85BB) will be shipped at the same time.

Sephiro Wood FT

Coating performance	Weather resistance	Installation
Hydrophilic Self-cleaning	Weather resistance grade ★	Installation Horizontal and Vertical



FW4871U



FW4872U



FW4873U



FW4874U

Specifications

Size	16×455(exposed width)×3030mm
Price	8,300 JPY /piece 6,020 JPY/m ²
Number of panel per package	2 pieces
Coverage	1.38m ² /piece
Weight	Approx. 25kg/piece

Outside corner

Shiplap corner

Vertical installation with clips

Outside corner l=455 Outside corner l=3030

16×outside:91(inside:75) ×455(exposed width) 16×outside:91(inside:75) ×3030

Accessories list

Genuine accessories are required to install siding panels

Panel	Outside corner l=455	Outside corner l=3030	Through Wall Flashing l=3030	Caulking (Holder set: B80E)	Repair Paint
FW4871U	FWD4871U	FWP4871U	B2241578	B84302715	B93HB1438BU
FW4872U	FWD4872U	FWP4872U	B2241423	B84303068	B93HB3072AU
FW4873U	FWD4873U	FWP4873U	B2241476	B8430708	B93HB2618AU
FW4874U	FWD4874U	FWP4874U	B2241W1	B8430713A	B93HB2632AU
Price	3,800 JPY /piece	17,500 JPY /piece	2,900 JPY /piece	6,000 JPY /piece	2,600 JPY /bottle
Number of panel per package	10 pieces/box (Ordering Unit 1piece)	1 piece	5 pieces/box	10 pieces/box*1 (Ordering Unit 1piece) Caulking(600ml)10pieces, Primer,brush,nozzle 2pieces *Holder set are sold separately	60g/bottle

*1 The dedicated primer (part number B85AA or B85BB) will be shipped at the same time.

Smash Line FT

Coating performance	Weather resistance	Installation
Hydrophilic Self-cleaning	Weather resistance grade ★	Installation Horizontal

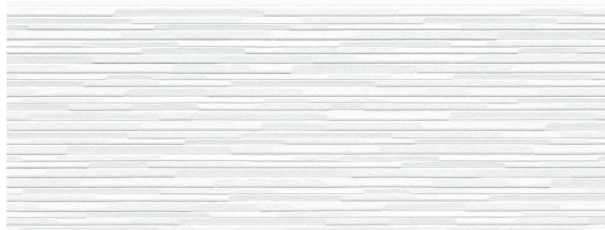

FW4881U



FW4882U



FW4883U



FW4884U

Specifications

Size	16×455(exposed width)×3030mm
Price	7,900JPY /piece 5,730JPY/m ²
Number of panel per package	2pieces
Coverage	1.38m ² /piece
Weight	Approx. 25kg/piece

Outside corner

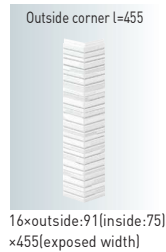

Accessories list

Genuine accessories are required to install siding panels

Panel	Accessories	Outside corner l=455	Caulking [Holder set: B80E]	Repair Paint
FW4881U		FWD4881U	B84303044	B93HB3051AU
FW4882U		FWD4882U	B84302491	B93HB2531AU
FW4883U		FWD4883U	B8430495	B93HB1438AU
FW4884U		FWD4884U	B84303045	B93HB3222AU
Price		3,800JPY /piece	6,000JPY /piece	2,600JPY /bottle
Number of panel per package		10 pieces/box (Ordering Unit 1piece)	10 pieces/box* ¹ (Ordering Unit 1piece) Caulking[600ml]10pieces, Primer,brush, nozzle2pieces *Holder set are sold separately	60g/bottle

*1 The dedicated primer (part number B85AA or B85BB) will be shipped at the same time.

Filltect Hydrophilic 16

Stripe 10 FT

Coating performance	Weather resistance	Installation
Hydrophilic Self-cleaning	Weather resistance grade ★	Installation Horizontal and Vertical



FW7161K



FW7162K



FW7163K



FW7164K



FW7165K



FW7167K

Specifications

Size	16×455(exposed width)×3030mm
Price	7,900JPY /piece 5,730JPY/m ²
Number of panel per package	2pieces
Coverage	1.38m ² /piece
Weight	Approx. 24kg/piece

Outside corner

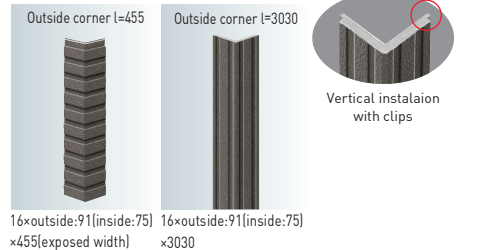

Accessories list

Genuine accessories are required to install siding panels

Accessories	Outside corner l=455	Outside corner l=3030	Through Wall Flashing l=3030	Caulking (Holder set: B80E)	Repair Paint
Panel					
FW7161K	FWD7161K	FWP7161K	B2241W2	B84302491B	B93HB2531AU
FW7162K	FWD7162K	FWP7162K	B2241549	B84303212	B93HB3212AU
FW7163K	FWD7163K	FWP7163K	B2241462	B84301758A	B93HB2583AU
FW7164K	FWD7164K	FWP7164K	B2241W3	B8430713	B93HB2416AU
FW7165K	FWD7165K	FWP7165K	B2241W1(Black)/B224W2(White)/B224W3(Brown)/B224W4(Gray)	B84303218	B93HB3218AU
FW7167K	FWD7167K	FWP7167K	B2241549	B84303219	B93HB3219AU
Price	3,800JPY /piece	17,500JPY /piece	2,900JPY /piece	6,000JPY /piece	2,600JPY /bottle
Number of panel per package	10 pieces/box (Ordering Unit 1piece)	1piece	5 pieces/box	10 pieces/box ^{*1} (Ordering Unit 1piece) Caulking(600ml)10pieces, Primer,brush,nozzle2pieces <small>*Holder set are sold separately</small>	60g/bottle

*1 The dedicated primer (part number B85AA or B85BB) will be shipped at the same time.

Strahl FT

Coating performance	Weather resistance	Installation
Hydrophilic Self-cleaning	Weather resistance grade ★	Installation Horizontal

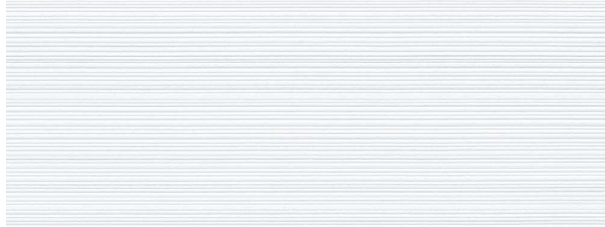

FW7171U



FW7172U



FW7173U



FW7175U

Specifications

Size	16×455(exposed width)×3030mm
Price	7,900JPY /piece 5,730JPY/m ²
Number of panel per package	2pieces
Coverage	1.38m ² /piece
Weight	Approx. 25kg/piece

Outside corner

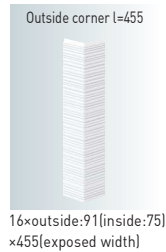

Accessories list

Genuine accessories are required to install siding panels

Panel	Accessories	Outside corner l=455	Caulking [Holder set: B80E]	Repair Paint
FW7171U		FWD7171U	B84303051	B93HB3051AU
FW7172U		FWD7172U	B84302491B	B93HB2531AU
FW7173U		FWD7173U	B8430746	B93HB1439AU
FW7175U		FWD7175U	B84303045	B93HB3222AU
Price		3,800JPY /piece	6,000JPY /piece	2,600JPY /bottle
Number of panel per package		10 pieces/box (Ordering Unit 1piece)	10 pieces/box* ¹ (Ordering Unit 1piece) Caulking[600ml]10pieces, Primer,brush,nozzle2pieces *Holder set are sold separately	60g/bottle

*1 The dedicated primer (part number B85AA or B85BB) will be shipped at the same time.

Fiotto FT

Coating performance	Weather resistance	Installation
Hydrophilic Self-cleaning	Weather resistance grade ★	Installation Horizontal and Vertical



FW4891U



FW4892U



FW4894U



FW4895U

Specifications

Size	16×455(exposed width)×3030mm
Price	7,900JPY /piece 5,730JPY/m ²
Number of panel per package	2pieces
Coverage	1.38m ² /piece
Weight	Approx. 25kg/piece

Outside corner

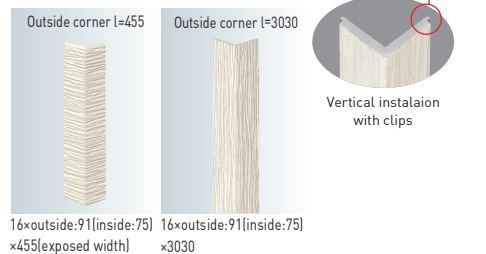

Accessories list

Genuine accessories are required to install siding panels

Panel	Outside corner l=455	Outside corner l=3030	Through Wall Flashing l=3030	Caulking (Holder set: B80E)	Repair Paint
FW4891U	FWD4891U	FWP4891U	B2241W2	B8430577	B93HB2540AU
FW4892U	FWD4892U	FWP4892U	B2241W2	B8430495	B93HB1438AU
FW4894U	FWD4894U	FWP4894U	B2241W3	B8430713A	B93HB2416AU
FW4895U	FWD4895U	FWP4895U	B2241557	B84302546	B93HB2546AU
Price	3,800JPY /piece	17,500JPY /piece	2,900JPY /piece	6,000JPY /piece	2,600JPY /bottle
Number of panel per package	10 pieces/box (Ordering Unit 1piece)	1piece	5 pieces/box	10 pieces/box ^{*1} (Ordering Unit 1piece) Caulking(600ml)10pieces, Primer,brush,nozzle 2pieces <small>*Holder set are sold separately</small>	60g/bottle

*1 The dedicated primer (part number B85AA or B85BB) will be shipped at the same time.

Scre Flat FT

Coating performance	Weather resistance	Installation
Hydrophilic Self-cleaning	Weather resistance grade ★	Installation Horizontal and Vertical

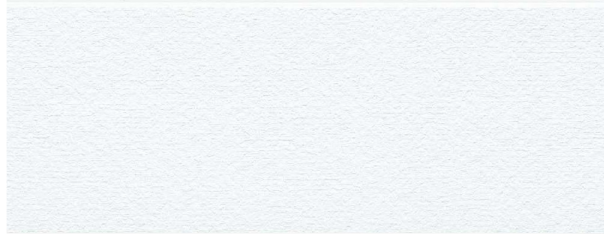

FW7281A



FW7282A

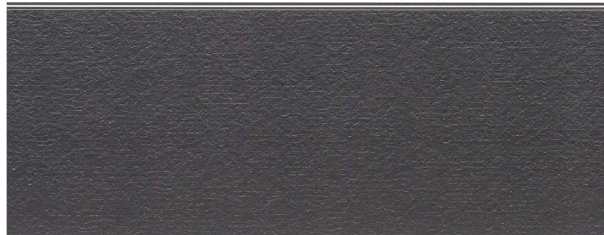

FW7283A

Specifications

Size	16×455(exposed width)×3030mm
Price	7,900JPY /piece 5,730JPY/m ²
Number of panel per package	2pieces
Coverage	1.38m ² /piece
Weight	Approx. 25kg/piece

Outside corner

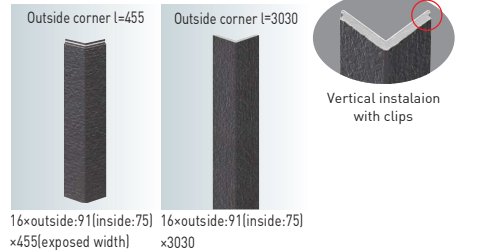

Accessories list

Genuine accessories are required to install siding panels

Accessories	Outside corner l=455	Outside corner l=3030	Through Wall Flashing l=3030	Caulking (Holder set: B80E)	Repair Paint
Panel					
FW7281A	FWD7281A	FWP7281A	B22413058	B84303051	B93HB3051AA
FW7282A	FWD7282A	FWP7282A	B2241W2	B84302491	B93HB2531AA
FW7283A	FWD7283A	FWP7283A	B2241W1	B84303045	B93HB3222BA
Price	3,800JPY /piece	17,500JPY /piece	2,900JPY /piece	6,000JPY /piece	2,600JPY /bottle
Number of panel per package	10 pieces/box (Ordering Unit 1piece)	1piece	5 pieces/box	10 pieces/box ^{*1} (Ordering Unit 1piece) Caulking(600ml)10pieces, Primer,brush,nozzle2pieces <small>*Holder set are sold separately</small>	60g/bottle

*1 The dedicated primer (part number B85AA or B85BB) will be shipped at the same time.



Narrow shaped outside corner

Narrow shaped outside corner Material: Coated galvanized steel



Narrow shaped outside corner for 18mm thickness panels brown



Narrow shaped outside corner for 16mm thickness panels gray



Installation Procedure 1
Install the Narrow shaped outside corner.

Installation Procedure 2
Cut a 45 degree angle at the siding edge. [Please use a tool which can cut a 45 degree angle at the siding edge.]

Installation Procedure 3
Install siding panel.

Narrow shaped outside corner for 18mm thickness panels				
Color	black	white	brown	gray
Shape				
Item number	B2161W1	B2161W2	B2161W3	B2161W4
Price	8,100 JPY/piece			
Number of panel per package	4 pieces/box			

Narrow shaped outside corner for 16mm & 14mm thickness panels				
Color	black	white	brown	gray
Shape				
Item number	B215W1	B215W2	B215W3	B215W4
Price	8,100 JPY/piece			
Number of panel per package	4 pieces/box			

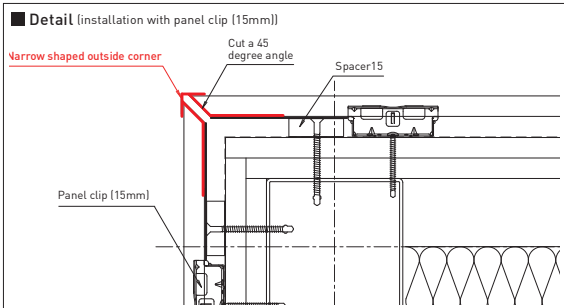

W shaped outside corner

W shaped outside corner

Material: Coated galvanized steel

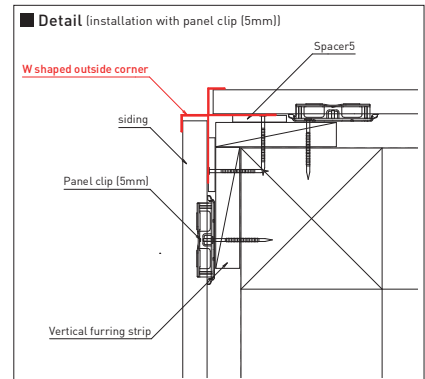
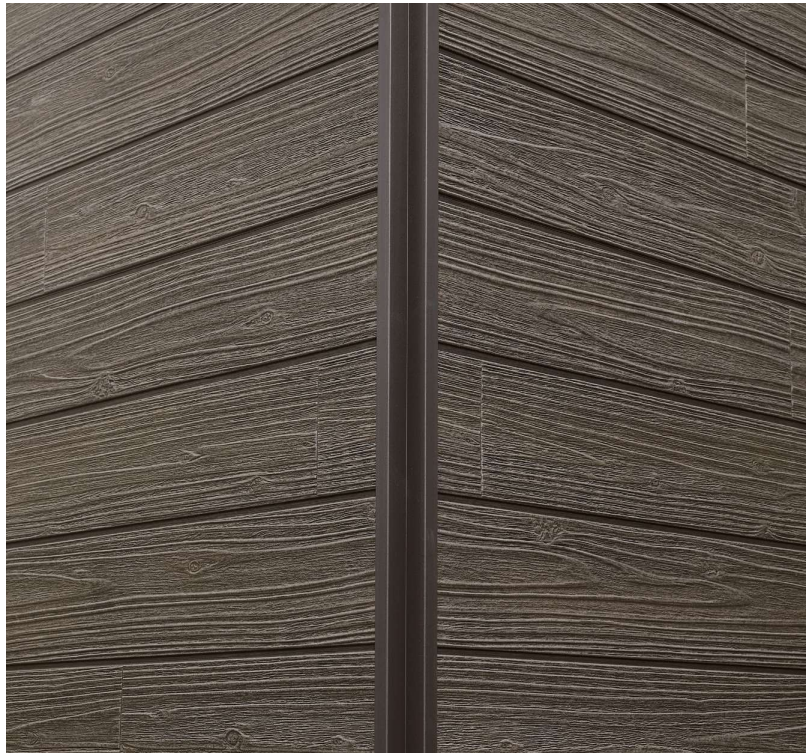

W shaped outside corner for 18mm thickness panels brown

W shaped outside corner for 18mm thickness panels				
Color	black	white	brown	gray
Shape				
Item number	B2171W1	B2171W2	B2171W3	B2171W4
Price	10,400 JPY/piece			
Number of panel per package	4 pieces/box			

W shaped outside corner for 16mm & 14mm thickness panels				
Color	black	white	brown	gray
Shape				
Item number	B2172W1	B2172W2	B2172W3	B2172W4
Price	10,400 JPY/piece			
Number of panel per package	4 pieces/box			

Horizontal Application (for 5mm panel clip)

Products

Filltect

Neorock

Excellage

Ceradier

Clip[5mm]				
	Panel Clip		Corner Clip	Starter bar for horizontal application
Shape				
Item number	B1005	B1305	B10053	B101052
Price	9,700JPY/bag		5,800JPY/bag	1,950JPY/piece
Number of panel per package	70 pieces/bag		50 pieces/bag	4 pieces/box
Material	Hot-dip zinc-aluminum magnesium alloy coated steel		Hot-dip zinc-aluminum magnesium alloy coated steel	Hot-dip zinc-aluminum magnesium alloy coated steel

Clip Fixing Component					
	Clip Screw25 (for wood substructure)	Clip Screw35 (for wood substructure)	Clip Screw19 (for steel substructure)	Clip Screw16 (for steel substructure)	Clip Screw30 (for steel substructure)
Shape			 Sub Structure thickness :1.6 to 2.3mm	 Sub Structure thickness :1.2mm	 Sub Structure thickness :1.2mm
Item number	RY8830	B881135	RY8840	B885116	B885130
Price	9,500JPY/box	9,500JPY/box	12,400JPY/box	13,700JPY/box	17,300JPY/box
Number of panel per package	500 pieces/box	500 pieces/box	500 pieces/box	500 pieces/box	500 pieces/box
Material	Stainless Steel	Stainless Steel	Stainless Steel	Stainless Steel	Stainless Steel

Spacer		
	Spacer5 (for openings and eaves)	Spacer2 (for land adjustment)
Shape		
Item number	RY82505	RY82502
Price	19,700JPY/box	16,400JPY/box
Number of panel per package	20 pieces/box	20 pieces/box
Material	Polypropylene	Polypropylene

Flashing	
Internal Flashing	Sill Flashing50
RCILK	black B238W1 white B238W2 brown B238W3 gray(metalic) B238W4
1,270JPY/piece	2,900JPY/piece
20 pieces/box	5 pieces/box
Coated galvanized steel	Coated galvanized steel

Soffit Flashing						
	For 21mm thickness		For 18mm thickness		For 16/15mm thickness	
Shape	black B255W1 white B255W2 brown B255W3 gray(metalic) B255W4		black B254W1 white B254W2 brown B254W3 gray(metalic) B254W4		black B253W1 white B253W2 brown B253W3 gray(metalic) B253W4	
Price	3,000JPY/piece		2,700JPY/piece		2,600JPY/piece	
Number of panel per package	5 pieces/box		5 pieces/box		5 pieces/box	
Material	Coated galvanized steel		Coated galvanized steel		Coated galvanized steel	

Face Nail				
Face Nail50(for wood substructure) For 21/18mm thickness	Face Nail45(for wood substructure) For 16/15mm thickness	Face Screw50 (for steel substructure)	Face Screw45 (for steel substructure)	Face Screw60 (for steel substructure)
		 Sub Structure thickness :1.6 to 2.3mm	 Sub Structure thickness :1.2mm	 Sub Structure thickness :1.2mm
B8750R400	B8745R400	B88501	B885245	B885260
720JPY/bag	530JPY/bag	8,600JPY/box	14,200JPY/box	11,400JPY/box
40 pieces/bag	40 pieces/bag	200 pieces/box	300 pieces/box	200 pieces/box
Stainless Steel	Stainless Steel	Stainless Steel	Stainless Steel	Stainless Steel

Joint Component			
Metal Caulking Joiner		T-shaped joiner	L-shaped joiner
For 18/16mm thickness	For 18/16mm thickness(one-side)		
		 black B3616F1 white B3616F2 brown B3616F3 dark stainless B3616F4	 black B3616KF1 white B3616KF2 brown B3616KF3 dark stainless B3616KF4
B2721	B2718K		
1,850JPY/piece	1,820JPY/piece	5,900JPY/piece	5,500JPY/piece
15 pieces/box	15 pieces/box	15 pieces/box	15 pieces/box
Hot-dip zinc-aluminum magnesium alloy coated steel	Hot-dip zinc-aluminum magnesium alloy coated steel	Aluminum	Aluminum

Repair Component	Waterproof Component	
Repair Putty	Waterproof Sealer	Waterproof Sealer for Filtect
B4901	RM875	LTKBM3103C
3,400JPY/piece	3,300JPY/bottle	21,200JPY/bottle
1 pieces/350g	1 bottle/100g	1 bottle/1liter
Acrylic emulsion	—	—

Vertical Application (for 5mm panel clip)

Products

Filltect Neorock Excellage Ceradier

Clip[5mm]					
	Panel Clip		Corner Clip	Starter bar for vertical application	Corner cap for starter bar
Shape					
Item number	B1005	B1305	RE10058	B130571	B293W1D
Price	9,700JPY/bag		4,000JPY/bag	5,900JPY/piece	3,500JPY/bag
Number of panel per package	70 pieces/bag		34 pieces/bag	5 pieces/box	10 pieces/bag
Material	Hot-dip zinc-aluminum magnesium alloy coated steel		Hot-dip zinc-aluminum magnesium alloy coated steel	Hot-dip zinc-aluminum magnesium alloy coated steel	Coated galvanized steel

Face Nail					
	Face Nail50(for wood substructure) For 18mm thickness	Face Nail45(for wood substructure) For 16/15mm thickness	Face Screw50 (for steel substructure)	Face Screw45 (for steel substructure)	Face Screw60 (for steel substructure)
Shape			 Sub Structure thickness :1.6 to 2.3mm	 Sub Structure thickness :1.2mm	 Sub Structure thickness :1.2mm
Item number	B8750R400	B8745R400	B88501	B885245	B885260
Price	720JPY/bag	530JPY/bag	8,600JPY/box	14,200JPY/box	11,400JPY/box
Number of panel per package	40 pieces/bag	40 pieces/bag	200 pieces/box	300 pieces/box	200 pieces/box
Material	Stainless Steel	Stainless Steel	Stainless Steel	Stainless Steel	Stainless Steel

Spacer		
	Spacer5 (for openings and eaves)	Spacer2 (for land adjustment)
Shape		
Item number	RY82S05	RY82S02
Price	19,700JPY/box	16,400JPY/box
Number of panel per package	20 pieces/box	20 pieces/box
Material	Polypropylene	Polypropylene

Flashing	
Internal Flashing	Sill Flashing 50
 RCILK	 black B238W1 white B238W2 brown B238W3 gray(metalic) B238W4
1,270JPY/piece	2,900JPY/piece
20 pieces/box	5 pieces/box
Coated galvanized steel	Coated galvanized steel

Repair Component	
	Repair Putty
Shape	
Item number	B4901
Price	3,400JPY/piece
Number of panel per package	1 pieces/350g
Material	Acrylic emulsion

Waterproof Component	
Waterproof Sealer	Waterproof Sealer for Filltect
RM875	LTKBM3103C
3,300JPY/bottle	21,200JPY/bottle
1 bottle/100g	1 bottle/1liter
—	—

Clip Fixing Component				
Clip Screw25 (for wood substructure)	Clip Screw35 (for wood substructure)	Clip Screw19 (for steel substructure)	Clip Screw16 (for steel substructure)	Clip Screw30 (for steel substructure)
		 Sub Structure thickness :1.6 to 2.3mm	 Sub Structure thickness :1.2mm	 Sub Structure thickness :1.2mm
RY8830	B881135	RY8840	B885116	B885130
9,500JPY/box	9,500JPY/box	12,400JPY/box	13,700JPY/box	17,300JPY/box
500 pieces/box	500 pieces/box	500 pieces/box	500 pieces/box	500 pieces/box
Stainless Steel	Stainless Steel	Stainless Steel	Stainless Steel	Stainless Steel

Joint Component			
Metal Caulking Joiner		T-shaped joiner	L-shaped joiner
For 18/16mm thickness	For 18/16mm thickness(one-side)		
		 black B3616F1 white B3616F2 brown B3616F3 dark stainless B3616F4	 black B3616KF1 white B3616KF2 brown B3616KF3 dark stainless B3616KF4
B2721	B2718K		
1,850JPY/piece	1,820JPY/piece	5,900JPY/piece	5,500JPY/piece
15 pieces/box	15 pieces/box	15 pieces/box	15 pieces/box
Hot-dip zinc-aluminum magnesium alloy coated steel	Hot-dip zinc-aluminum magnesium alloy coated steel	Aluminum	Aluminum

Through Wall Flashing
For 18/16/15mm thickness
2,900JPY/piece
5 pieces/box
Coated galvanized steel

Horizontal Application (for 15mm panel clip)

Products

Filltect

Neorock

Excellage

Ceradier

Clip(15mm)			
	Panel Clip	Corner Clip	Starter bar for horizontal application
Shape			
Item number	B10115	B101153	B101152
Price	5,300JPY/bag	2,700JPY/bag	3,500JPY/piece
Number of panel per package	30 pieces/bag	20 pieces/bag	4 pieces/box
Material	Hot-dip zinc-aluminum magnesium alloy coated steel	Hot-dip zinc-aluminum magnesium alloy coated steel	Hot-dip zinc-aluminum magnesium alloy coated steel

Clip Fixing Component				
	Clip Screw25 (for wood substructure)	Clip Screw35 (for wood substructure)	Clip Screw55 (for wood substructure)	Clip Screw19 (for steel substructure)
Shape				 Sub Structure thickness :1.6 to 2.3mm
Item number	RY8830	B881135	B88553	RY8840
Price	9,500JPY/box	9,500JPY/box	9,200JPY/box	12,400JPY/box
Number of panel per package	500 pieces/box	500 pieces/box	200 pieces/box	500 pieces/box
Material	Stainless Steel	Stainless Steel	Stainless Steel	Stainless Steel

Face Nail					
	Face Nail65 (for wood substructure)	Face Screw60 (for steel substructure)	Face Screw50 (for steel substructure)	Face Screw45 (for steel substructure)	Face Screw60 (for steel substructure)
	21/For 18/16/15mm thickness	For 21mm thickness	For 18/16/15mm thickness		
Shape		 Sub Structure thickness :1.6 to 2.3mm	 Sub Structure thickness :1.6 to 2.3mm	 Sub Structure thickness :1.2mm	 Sub Structure thickness :1.2mm
Item number	B8765R400	B8860	B88501	B885245	B885260
Price	1,140JPY/bag	13,500JPY/box	8,600JPY/box	14,200JPY/box	11,400JPY/box
Number of panel per package	40 pieces/bag	200 pieces/box	200 pieces/box	300 pieces/box	200 pieces/box
Material	Stainless Steel	Stainless Steel	Stainless Steel	Stainless Steel	Stainless Steel

Flashing		
	Internal Flashing	Sill Flashing 50
Shape		
Item number	RCILK	B238W1 white B238W2 brown B238W3 gray(metalic) B238W4
Price	1,270JPY/piece	2,900JPY/piece
Number of panel per package	20 pieces/box	5 pieces/box
Material	Coated galvanized steel	Coated galvanized steel

Soffit Flashing				
	For 21mm thickness		For 18mm thickness	
Shape				
Item number	black B255W1 white B255W2 brown B255W3 gray(metalic) B255W4	black B254W1 white B254W2 brown B254W3 gray(metalic) B254W4		
Price	3,000JPY/piece	2,700JPY/piece		
Number of panel per package	5 pieces/box	5 pieces/box		
Material	Coated galvanized steel	Coated galvanized steel		

Long clip	
B10155	
3,600JPY/piece	
6 pieces/box	
Hot-dip zinc-aluminum magnesium alloy coated steel	

Clip Screw16 (for steel substructure)	Clip Screw30 (for steel substructure)
Sub Structure thickness :1.2mm	Sub Structure thickness :1.2mm
B885116	B885130
13,700JPY/box	17,300JPY/box
500 pieces/box	500 pieces/box
Stainless Steel	Stainless Steel

Spacer	
Spacer15 (for openings and eaves)	Spacer2 (for land adjustment)
RY82S15	RY82S02
13,800JPY/box	16,400JPY/box
6 pieces/box	20 pieces/box
Polypropylene	Polypropylene

Joint Component	
Metal Caulking Joiner	
For 18/16mm thickness	For 18/16mm thickness(one-side)
B2722	B2719K
3,050JPY/piece	3,180JPY/piece
15 pieces/box	15 pieces/box
Hot-dip zinc-aluminum magnesium alloy coated steel	Hot-dip zinc-aluminum magnesium alloy coated steel

For 16/15mm thickness	
black B253W1 white B253W2 brown B253W3 gray(metalic) B253W4	
2,600JPY/piece	
5 pieces/box	
Coated galvanized steel	

Repair Component
Repair Putty
B4901
3,400JPY/piece
1 pieces/350g
Acrylic emulsion

Waterproof Component	
Waterproof Sealer	Waterproof Sealer for Filtect
RM875	LTKBM3103C
3,300JPY/bottle	21,200JPY/bottle
1 bottle/100g	1 bottle/1liter
—	—

Vertical Application (for 15mm panel clip)

Products

Filltect

Neorock

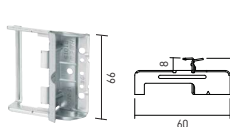
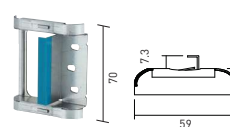
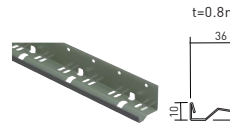

Excellage

Ceradier

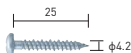
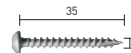
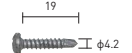
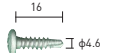
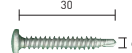
Clip(15mm)			
	Panel Clip	Corner Clip	Starter bar for vertical application
Shape	 t=0.8mm 66, 60, 15, 7.8, 8	 t=0.8mm 70, 59, 7.3, 15	 t=0.8mm L=3030mm 36, 38.6
Item number	B10115	RE10158	B10157HG
Price	5,300JPY/bag	7,700JPY/bag	5,200JPY/piece
Number of panel per package	30 pieces/bag	34 pieces/bag	5 pieces/box
Material	Hot-dip zinc-aluminum magnesium alloy coated steel	Hot-dip zinc-aluminum magnesium alloy coated steel	Hot-dip zinc-aluminum magnesium alloy coated steel

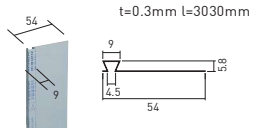
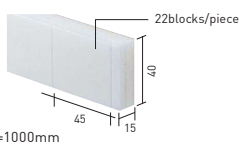
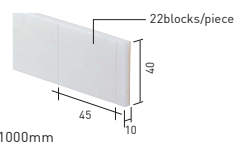
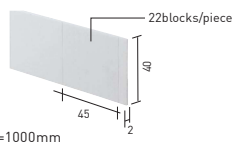
Clip Fixing Component					
	Clip Screw25 (for wood substructure)	Clip Screw35 (for wood substructure)	Clip Screw19 (for steel substructure)	Clip Screw16 (for steel substructure)	Clip Screw30 (for steel substructure)
Shape	 25, φ4.2	 35, φ4.1	 19, φ4.2 Sub Structure thickness :1.6 to 2.3mm	 16, φ4.6 Sub Structure thickness :1.2mm	 30, φ4.6 Sub Structure thickness :1.2mm
Item number	RY8830	B881135	RY8840	B885116	B885130
Price	9,500JPY/box	9,500JPY/box	12,400JPY/box	13,700JPY/box	17,300JPY/box
Number of panel per package	500 pieces/box	500 pieces/box	500 pieces/box	500 pieces/box	500 pieces/box
Material	Stainless Steel	Stainless Steel	Stainless Steel	Stainless Steel	Stainless Steel

	Joint Component	Spacer		
	Metal Caulking Joiner For 18/16mm thickness(one-side)	Spacer15 (for openings and eaves)	Spacer10	Spacer2 (for land adjustment)
Shape	 t=0.3mm l=3030mm 54, 9, 4.5, 15.8	 22blocks/piece l=1000mm 45, 15, 48	 22blocks/piece l=1000mm 45, 10, 48	 22blocks/piece l=1000mm 45, 2, 48
Item number	B2713K	RY82S15	RY82S10	RY82S02
Price	1,430JPY/piece	13,800JPY/box	16,400JPY/box	16,400JPY/box
Number of panel per package	15 pieces/box	6 pieces/box	10 pieces/box	20 pieces/box
Material	Hot-dip zinc-aluminum magnesium alloy coated steel	Polypropylene	Polypropylene	Polypropylene



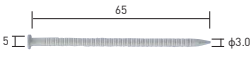
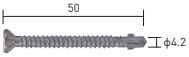
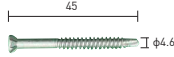
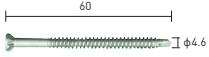

	Repair Component	Waterproof Component	
	Repair Putty	Waterproof Sealer	Waterproof Sealer for Filltect
Shape			
Item number	B4901	RM875	LTKBM3103C
Price	3,400JPY/piece	3,300JPY/bottle	21,200JPY/bottle
Number of panel per package	1 pieces/350g	1 bottle/100g	1 bottle/1liter
Material	Acrylic emulsion	—	—

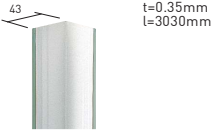
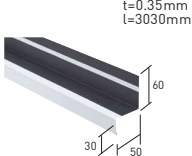
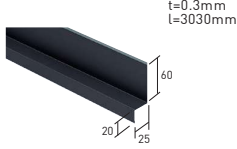
Corner cap for starter bar	
	
B291W1D	
3,500 JPY/bag	
10 pieces/bag	
Coated galvanized steel	



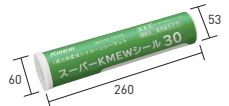

Face Nail			
Face Nail65(for wood substructure)	Face Screw50(for steel substructure)	Face Screw45 (for steel substructure)	Face Screw60 (for steel substructure)
For 18/16/15mm thickness	For 18/16/15mm thickness	For 18/16/15mm thickness	For 18/16/15mm thickness
	 Sub Structure thickness :1.6 to 2.3mm	 Sub Structure thickness :1.2mm	 Sub Structure thickness :1.2mm
B8765R400	B88501	B885245	B885260
1,140 JPY/bag	8,600 JPY/box	14,200 JPY/box	11,400 JPY/box
40 pieces/bag	200 pieces/box	300 pieces/box	200 pieces/box
Stainless Steel	Stainless Steel	Stainless Steel	Stainless Steel

Flashing		
Internal Flashing	Sill Flashing 50	Through Wall Flashing For 18/16/15mm thickness
	 black B238W1 white B238W2 brown B238W3 gray(metalic) B238W4	
RCILK		
1,270 JPY/piece	2,900 JPY/piece	2,900 JPY/piece
20 pieces/box	5 pieces/box	5 pieces/box
Coated galvanized steel	Coated galvanized steel	Coated galvanized steel

Caulking materials

	Caulking materials	Caulking Gun for Soft Cartridge (Built-in holder)	Caulking Gun for Soft Cartridge (without built-in holder)	Holder Sets
Shape	 600ml	 600ml		 280mm length, 67mm height
Item number	each color	B80G	B801G	B80E
Price	6,000JPY /piece	21,700JPY /piece	6,000JPY /piece	3,700JPY /set
Number of panel per package	10pieces/box (Ordering Unit 1piece) [Primer,brush,nozzle2pieces]	1piece/box	1piece/bag	1set/bag
	Material : Modified silicone			holder2pieces,nozzle2pieces

The dedicated primer (part number B85AA or B85BB) will be shipped at the same time.
One can of primer is included per quantity of 1-5 caulking.

	Nozzle Sets	Nozzle Attachment for soft cartridge	Long and bent nozzle sets	Bent nozzle sets
Shape				
Item number	B80N	B801A	B804N	B805N
Price	2,200JPY /bag	860JPY /bag	1,130JPY /bag	1,260JPY /bag
Number of panel per package	1set/bag	1set/bag	1set/bag	1set/bag
	nozzle5pieces		attachment1piece	long nozzle1piece bent nozzle1pieces

Use with nozzle set (B804N, B805N).

Use with attachment (B801A).



KMEW

Quality Distributed By



KMEW Co.,Ltd.

Head office: 13F, Crystal Tower Bldg.,
1-2-27 Shiromi, Chuo-ku, Osaka, Japan